

Foreword	02
Precautions	02
Package Contents	03
Name of components	03
Battery	06
Power Management	07
Mount / Unmount flash	08
Flash Mode: E-TTL Autoflash	08
1. E-TTL Mode	
2. FEC(Flash Exposure Compensation)	
3. FEB(Flash Exposure Bracketing)	
4. FEL: Flash Exposure Lock	
5. HSS: High Speed Sync	
6. Second-Curtain Sync	
M: Manual Flash	12
Multi: Stroboscopic Flash	13
Wireless Flash Shooting: Wireless (2.4G) Transmission	14
1. Wireless Settings	
2. Turn off TX unit flash	
3. Setting the communication channel	
4. Wireless ID Settings	
5. Scan for a free, unused channel	
6. Built in 2.4G Wireless Q and X Systems	
7. E-TTL: Automatic wireless flash photography	
8. M: Manual Wireless Flash Shooting	
9. Multi: Wireless Flash Shooting with Manual Flash	
Wireless Flash Shooting: Wireless (2.4G) Transmission	22
Other Applications	22
1. TCM - One key switching E-TTL/M mode	
2. Sync Triggering	
3. Auto Focus Assist Beam	
4. Bounce Flash	
5. ZOOM: Set the flash coverage	
6. Modeling Lamp	
7. Modeling Flash	
C.Fn: Setting Custom Functions	25
Control using the Camera's Menu Screen	26
Protection Function	27
Technical Data	28
Troubleshooting	29
Compatible Cameras	30
Restore factory settings	30
Firmware upgrade	30

Thank you for your purchase of a **NEEWER**[®] product.

This Z2PRO-C camera flash has been designed with the Canon EOS series cameras in mind and is compatible with E-TTL II autoflash feature. Simplify your shoots with this E-TTL compatible flash which allows the user to obtain the correct flash exposure even in more complex environments with variable lighting levels. This camera flash features:

- Maximum flash power of 76Ws, 81 levels of dimming (1/1~1/256)
- The upgraded quartz tube supports up to 100,000 flashes during its lifespan.
- 3000mAh Li-polymer battery with an autonomy of 600 flashes at full power, 1.5 seconds fast recharge.
- Supports E-TTL auto flash, which can be used as the master or slave unit of a wireless multi-lamp flash system - making shooting easier and faster.
- LCD screen for an intuitive display and easy operation.
- Built-in 2.4GHz wireless transmission, Integrated transmitter and receiver with a large radius.
- Supports manual frequency flash mode, HSS/second curtain sync /FEC and other E-TTL II functions.
- Stable output, High speed continuous flash and color temperature with good even lighting.
- Firmware will be upgraded as the camera is updated.

Precautions

1. Always keep this product dry.
2. Keep this product out of reach of children.
3. Do not disassemble or modify the product.
4. Do not subject to any form of physical shock. The product shouldn't be exposed to fire or an environment where the temperature exceeds 50 degrees.
5. Do not fire the flash directly into the eyes which could result in visual impairment.
6. Do not use the product near chemicals, flammable gases or other volatile substances which may cause fire or electromagnetic interference.
7. Do not use in the rain or in damp conditions.
8. Turn off the product immediately, if it appears to be operating abnormally, and try to troubleshoot the likely cause.
9. Failure to comply with the recommendations and warnings listed in the manual will invalidate the warranty.

Package Contents

EN

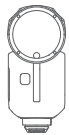

Flash unit ×1

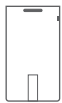

Lithium Battery ×1



Mini stand ×1



USB power cord ×1

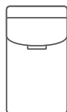

Protective Case ×1



Manual ×1

Name of components

1. Flash Body

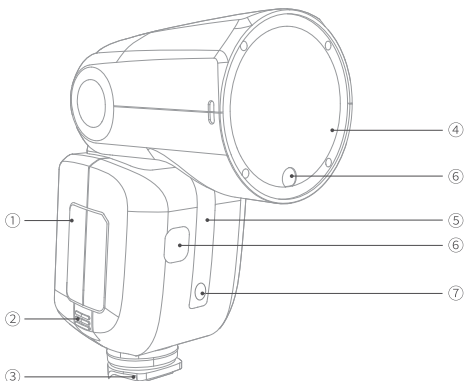

- ① Lithium Battery
- ② Battery Release Button
- ③ Hot Shoe Base
- ④ Flash Head
- ⑤ Wireless Sensor
- ⑥ Modeling Lamp
- ⑦ Focus Assist Lamp

Name of components

EN

2. Control Panel

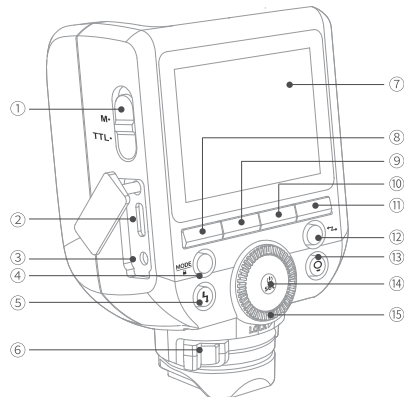

- ① <TCM> One-touch Switching
- ② Type-C USB Upgrade Port
- ③ Sync Jack
- ④ <MODE> Mode Selection/Lock Button
- ⑤ <⚡> Test Flash Button/Recycling Indicator
- ⑥ Hot Shoe Fixing Button
- ⑦ Display
- ⑧ Function Button 1
- ⑨ Function Button 2
- ⑩ Function Button 3
- ⑪ Function Button 4
- ⑫ <↔> Wireless Button
- ⑬ <⦿> Modeling Lamp
- ⑭ Power ON-OFF/Setting Button
- ⑮ Adjustment Knob

※ The USB Type-C port is exclusively intended for flash firmware upgrades and is not designed for charging purposes.

3. LCD Panel

(1) E-TTL Autoflash

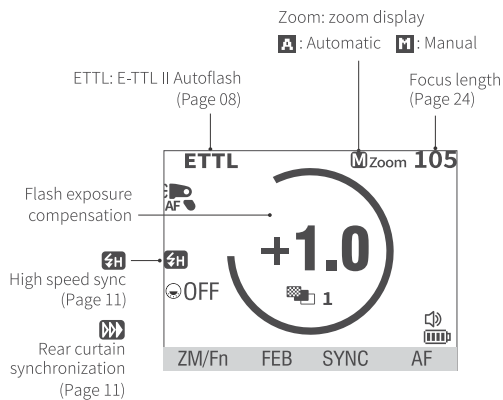

(2) M Manual Flash(Page 12)

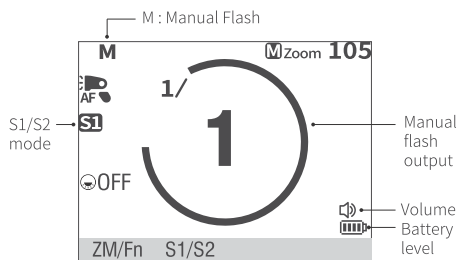

(3) Multi Flash(Page 13)

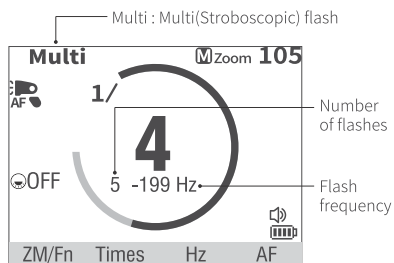

(4) Wireless Transmission Shooting(Page 14)

① Transmitter Unit

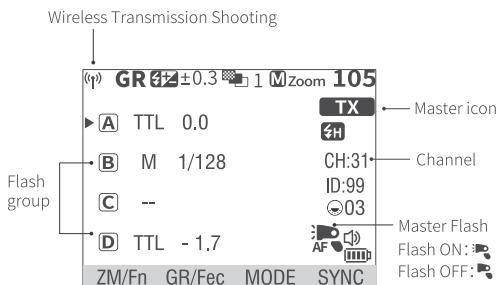

② RX unit

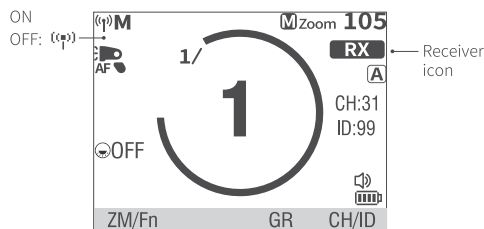

Battery

1. Features

- ① This flash unit uses Li-ion polymer battery which boasts a long service life and can be charged / discharged up to 500 times.
- ② Safe and reliable, the built-in circuit protects against overcharge, overdischarge, overcurrent, and short circuit.

2. Caution

- ① Do not short circuit.
- ② Do not immerse the battery in water.
- ③ Keep the battery out of reach of children.
- ④ Do not exceed 24 hours of continuous charging.
- ⑤ Store the battery in a dry, cool and ventilated environment.
- ⑥ Do not place the battery near or in a fire.
- ⑦ Dead batteries should be disposed according to local regulations.
- ⑧ If the battery isn't to be used for some time, please ensure it is charged at least every 3 months.

3. Inserting and Removing the Battery

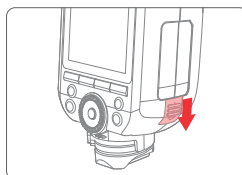

- ① Removing the battery
Slide the button in the direction shown to remove the battery.

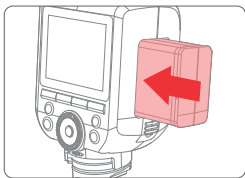

② Inserting the battery

Insert the lithium battery into the battery compartment in the direction indicated by the battery until the fastener snaps into place.

4. Battery Level Indicator

Make sure the battery is securely inserted in the flash. Check the battery level indication on the LCD panel to see the remaining battery level.

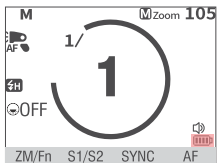

Battery Level Indicator	Indicates
4 bars	Full
3 bars	Medium
2 bars	Low
1 bar	Very low
Empty bar	Low battery. Please charge as soon as possible
Flashing	Battery is about to run out. The flash will no longer work. Please recharge the battery as soon as possible (within 10 days), the battery can then be used or stored for a long period.

Power Management

Use ON/OFF Power Switch to power the flash unit on or off. Please turn off the power if the flash won't be used for a long period. When setting as a transmitter (TX) flash, the flash will turn the power off automatically after a certain period (approx. 90 seconds) of inactivity. Pressing the camera shutter halfway or pressing any flash button will wake up the flash unit. When setting as a receiver (RX) flash, it will enter sleep mode after a certain period (adjustable, 60 minutes by default) of idle use. Pressing any flash button will reactivate device.

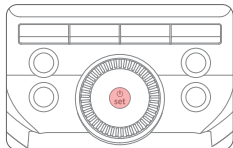

Press and hold the power button for 2s to turn the flash on/off.

Power Management

- Note: ① When used off the camera, it is recommended that you customize the function to disable "automatic power off".
- ② Receiver Auto Power Off Timer is set to 60 minutes by default. A 30 minute timer can also be applied.

Mount / Unmount flash

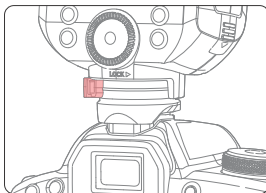

1. Mount the Camera Flash

Turn the locking ring to the left to fully insert the camera's hot shoe.

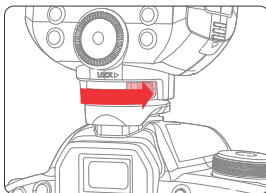

2. Secure the Camera Flash

Rotate the locking ring to the right until secure.

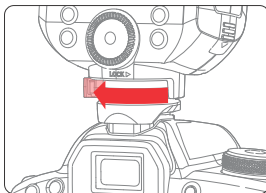

3. Unmount the Camera Flash.

Press the button and rotate the hotshoe locking ring to the left to loosen.

Flash Mode: E-TTL Autoflash

This flash has three flash modes: E-TTL, Manual (M), and Multi (Stroboscopic). In E-TTL mode, the camera's metering system detects flash illumination reflected from the subject and automatically adjusts the flash output to balance the exposure of the subject and background. Flash Exposure compensation (FEC), flash exposure bracketing (FEB), high-speed sync (HSS), second-curtain shutter sync, flash exposure lock (FEL), aperture preview shadow flash, and Canon camera menu access are supported.

※ Press < MODE > Mode Selection Button. The three flash modes will display on the LCD panel in a cycle.

1. E-TTL Mode

Press <MODE> Mode Selection Button to enter E-TTL mode.

- Press the camera release button halfway to focus.
- A pre-flash is fired moments before the shutter is released, and the flash receives camera information for the main flash.

2. FEC(Flash Exposure Compensation)

In FEC mode, the flash can adjust flash exposure compensation in 1/3-stop increments between ± 3 stops. This feature is useful when the TTL system needs to be fine-tuned to accommodate the shooting environment.

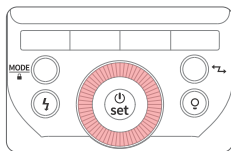

Set the flash exposure compensation amount.

- Turn the Select Dial to set the amount.
- "0.3" indicates 1/3 step, "0.7" indicates 2/3 step.
- To cancel the flash exposure compensation, set the amount to "0.0".

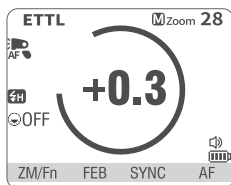

3. FEB(Flash Exposure Bracketing)

FEB(Flash surround Exposure) automatically changes the flash output in 1/3rd stops from -3 to +3. When using this function, the camera will record three photos with different flash outputs (correct exposure, underexposure, and overexposure). This function helps obtain correct exposure which is key when shooting moving objects or when environmental lighting is more complex.

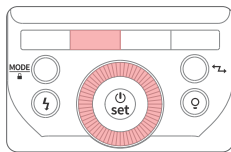

- Press function button 2 <FEB> so that the screen displays the <FEB> icon and the FEB amount will be highlighted on the LCD panel.

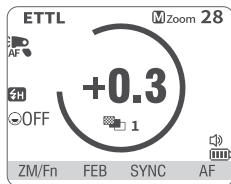

- Set the flash exposure compensation amount.
 - Turn the Select Dial to set the FEB amount.
 - "0.3" equates to 1/3 step, "0.7" equates to 2/3 step.

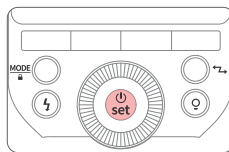

- Press Set Button again to confirm the setting. The FEC and FEB settings are displayed on the LCD panel.

* FEB will be canceled after three photos are taken.

* For FEB, set the camera drive mode to "single" and ensure the flash is ready before shooting.

* FEB can be used with FEC and FEL

* The Flash bracketing function will stop after taking three shots. This can be kept enabled in the camera customization menu settings.

4. FEL: Flash Exposure Lock

FEL can lock the correct flash exposure setting for any part of the scene.

With <ETTL> displayed on the LCD panel, press the camera's <FEL> button. If the camera does not have the <FEL> button, press the <*> button.

- Bring the subject into focus

- Press the <FEL> button

- Aim the center of the viewfinder at the subject, and then press the <FEL> button.

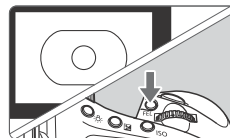

- The camera flash will fire a preflash and the required flash output for the subject is memorized.

- "FEL" will show in the viewfinder for 0.5 seconds.

- Each time the <FEL> button is pressed, a preflash will be fired and a new flash exposure setting will be locked.

* If the subject is too far away and underexposed, the <FEB> icon will flash in the viewfinder. Please approach the subject and try Flash Exposure Lock (FEL) function again.

* Flash exposure lock cannot be set if <ETTL> is not displayed on the LCD.

* Flash exposure lock may not work effectively if the subject is too small.

5. HSS: High Speed Sync

High Speed Sync (FP flash) enables the flash to synchronize with all camera shutter speeds. This is convenient when you want to use aperture priority for fill-flash portraits.

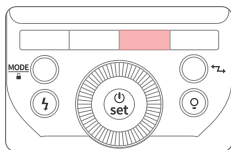

- ① Press Function Button 3 < SYNC > so that < FH > displays.

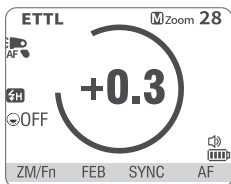

- ② Check that < FH > is displayed in the viewfinder.

* If the shutter speed is set to equal or slower than the camera's maximum flash sync speed, < FH > will not appear in the viewfinder.

* With high-speed sync, the faster the shutter speed, the shorter the effective flash range.

* To return to normal flash, press < SYNC > button again. Then < FH > will disappear.

* Multi flash mode cannot be set in high-speed sync mode.

* Over-temperature protection may be activated after 30 consecutive high-speed sync flashes.

6. Second-Curtain Sync

With a slow shutter speed, you can create a trail of light following the subject. The flash fires right before the shutter closes.

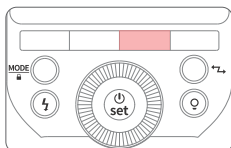

- Press Function Button 3 < SYNC > so that < SH > displays.

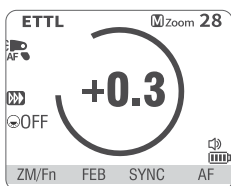

The flash output is adjustable from 1/1 full power to 1/256th power in 1/10th stop increments.

To obtain a correct flash exposure, use a hand-held flash meter to determine the required flash output.

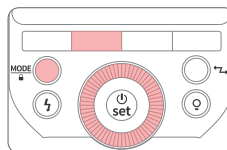

- ① Press <MODE> button so that <M> is displayed.

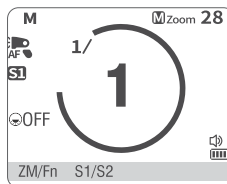

- ② Turn the Select Dial to set the flash output rating.

Press function button 2 to adjust the S1/S2 mode

* S1 Optical control unit setting

In M manual flash mode, the S1 function can be used and the flash unit can function as an optical secondary flash. It will fire synchronously when the main flash fires, the same effect as that obtained by the use of radio triggers. This helps the photographer create multiple lighting effects.

* S2 Optical control unit setting

In M manual flash mode, the S2 function can be used and the flash unit can function as an optical S2 secondary flash. In this mode, it will ignore the pre-flash emitted by the TTL flash and will only fire in response to the second flash from the main unit.

Note: S1 and S2 optical triggering is only available in M manual flash mode.

The term stroboscopic flash relates to a rapid series of flashes being fired. It can be used to capture multiple images of a moving subject in a single photograph.

You can set the firing frequency (number of flashes per sec. expressed as Hz), the number of flashes, and the flash output.

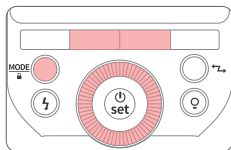

- (1) Press the <MODE> button so that <MULTI > displays.
- (2) Set the flash frequency and the number of flashes.

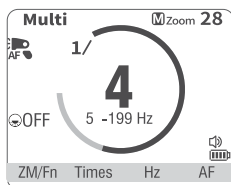

- ① Press the Function Button 2 <Times> to select the number of flashes. Turn the Select Dial to set the value.
- ② Press the Function Button 3 <Hz> to select the flash frequency. Turn the Select Dial to set the value.
- (3) Turn the adjustment knob to set the flash output power.

Calculating the Shutter Speed:

During a stroboscopic flash, the shutter remains open until the firing stops. Use the formula below to calculate the shutter speed and set it with the camera.

$$\text{Number of Flashes} / \text{Flash Frequency} = \text{Shutter Speed}$$

For example, if the number of flashes is 10 and the firing frequency is 5 Hz, the shutter speed should be at least 2 seconds.

* To avoid overheating and deterioration of the flash head, do not use the stroboscopic flash more than 10 times in succession. After 10 times, allow the camera flash to rest for at least 15 minutes. If you try to use the stroboscopic flash more than 10 times in succession, the flash may stop flashing automatically. This is to protect the flash head. Should this happen, please allow the camera to rest for 15 minutes.

* Stroboscopic flash is most effective with a highly reflective subject against a dark background.

* It is recommended to use a tripod and a remote control.

* A flash output of 1/1 and 1/2 cannot be set for stroboscopic flash mode.

* Stroboscopic flashes can be used with the “buLb” function.

* If the flash count is displayed as --, the flash will fire continuously until the shutter release or the battery is exhausted. The number of flashes will be limited as shown in the table below.

Maximum number of strobe flashes

Flash output \ Hz	1	2	3	4	5	6-7	8-9
1/4	8	6	4	3	3	2	2
1/8	14	14	12	10	8	6	5
1/16	30	30	30	20	20	20	10
1/32	60	60	60	50	50	40	30
1/64	90	90	90	80	80	70	60
1/128	100	100	100	100	100	90	80
1/256	100	100	100	100	100	90	80

Flash output \ Hz	10	11	12-14	15-19	20-50	60-199
1/4	2	2	2	2	2	2
1/8	4	4	4	4	4	4
1/16	8	8	8	8	8	8
1/32	20	20	20	18	16	12
1/64	50	40	40	35	30	20
1/128	70	70	60	50	40	40
1/256	70	70	60	50	40	40

Wireless Flash Shooting: Wireless (2.4G) Transmission

* When the camera's shooting mode is set to a fully automatic mode or an Image Zone mode, the operations explored in this chapter are not available. Please set the camera's shooting mode to P/Tv/Av/M/B (Creative Zone Mode).

* The Z2PRO-C attached to the camera is called the transmitter unit, and a Z2PRO-C that is wirelessly controlled is called the receiver unit.

Using a flash (transmitter/receiver) with a radio transmission wireless shooting function make it easy to shoot with advanced wireless multiple flash lighting, in the same way as E-TTL II autoflash shooting. The basic relative position and operation range are as shown in the picture. You can then perform wireless E-TTL II autoflash shooting by setting the transmitter unit to <ETTL>.

Positioning and Operation Range (Example of wireless flash shooting):

Autoflash Shooting with One Receiver Unit

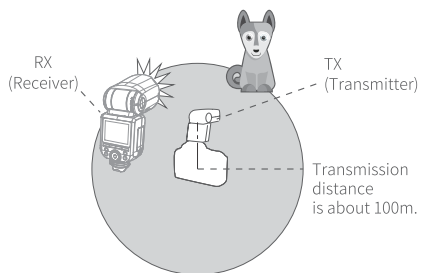

- * Use the supplied mini stand to position the Receiver unit.
- * Perform a test flash and test shot before shooting.
- * The transmission distance might be shorter depending on the conditions such as the positioning of the Receiver units, the surrounding environment and weather conditions.

Wireless Multiple Flash Shooting

You can split the RX unit into two or three groups and shoot E-TTL II Auto Flash while changing the flash ratio (focus). In addition, each flash group (up to four groups) can be set and shot with different flash modes.

① Auto flash shooting with two RX groups.

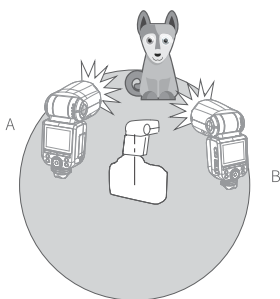

② Auto flash Shooting with three RX groups

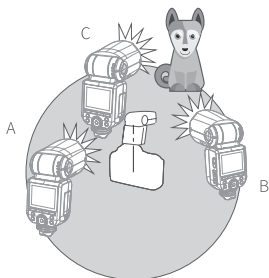

③ Shooting with a Different Flash Mode set for Each Group

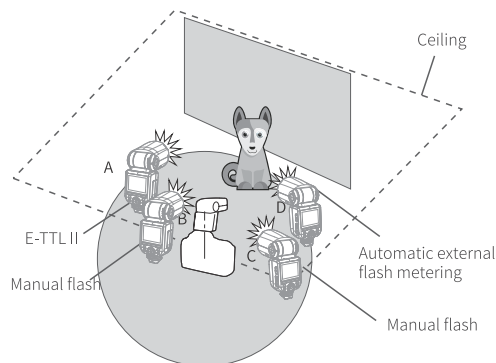

* The flash mode Settings shown above are only used as examples.

1. Wireless Settings

You can switch between normal flash and wireless flash. For normal flash, be sure to set wireless Settings to "off".

Transmitter (TX) Unit Setting

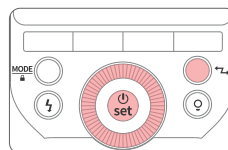

- ① Press the <Z> wireless setting button and turn the adjustment knob to select TX.

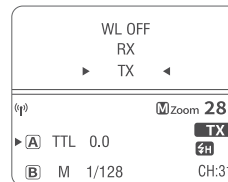

- ② Press the Setup button to confirm. The screen will display the symbols <A> and .

Receiver (RX) Unit Setting

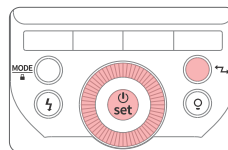

- ① Press the <Z> wireless setting button and turn the adjustment knob to select RX.

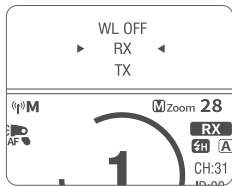

- ② Press the Setup button to confirm. The screen will display the symbols < (p) > and < RX >.

2. Turn off TX unit flash

When the Transmitter (TX) unit is set to OFF, only the Receiver (RX) units will fire a flash.

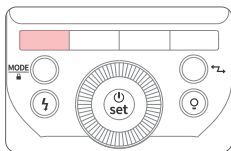

- ① Long press function button 1 <ZM/Fn> to enter custom <TX> setting.
- ② Set Transmitter to ON/OFF to control the On/Off of the Transmitter unit.



- * Even if the master unit is disabled, it will still fire a preflash in order to transmit wireless signals.

* After adjusting the settings, press function button 1 to exit

3. Setting the communication channel

If there is more than one wireless flash system nearby, you can change the communication channel to prevent signal interference. Ensure that the channel of the transmitter and receiver units are matching.

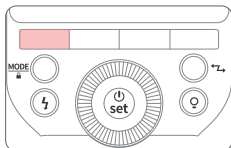

- ① Long press function button 1 <ZM/Fn> to enter custom CH settings.
- ② In Custom CH settings screen, turn the Select Dial to choose a channel from 1 to 32.



- * After setting, press function button 1 to exit

4. Wireless ID Settings

In addition to changing the wireless communication channel to avoid signal interference, you can also change the wireless ID to prevent interference. Set the channel and the wireless ID of the transmitter unit and the receiver unit to the same values. Go to C.Fn ID and choose wireless ID from 01 to 99. Select OFF to disable the wireless ID.

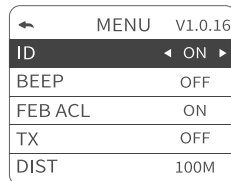

- * After setting, press function button 1 to exit.

5. Scan for a free, unused channel

To avoid the issue of interference by using the same channel(s) already in use by others, use this function: enter the C.Fn settings and find the SCAN option. When setting it to START, it will scan from 1% to 100%. The 8 spare channels will be displayed after the scan is completed.



- * After setting, press function button 1 to exit.

6. Built in 2.4G Wireless Q and X Systems

This flash features a built in 2.4G wireless Q system, and can be used as a master/slave unit, compatible with the NEEWER QPRO-C TTL transmitter (not included). In addition, it also supports the 2.4G wireless X system. Enter the custom menu and enable "RX COMPAT", and it can only be used as a slave unit, compatible with Godox Xpro/X3/X2 transmitters and other X system master lights.

Note: The Q and X systems cannot be used simultaneously.

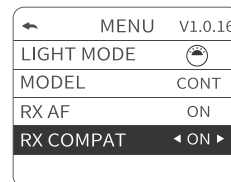

- * After setting, press function button 1 to exit.

7. E TTL: Automatic wireless flash photography

Note: The transmitter (TX) unit and the receiver (RX) unit must have the same wireless ID, channel and group before the flashes can be fired wirelessly.

Using Automatic Wireless Flash with a Single Receiver Unit.

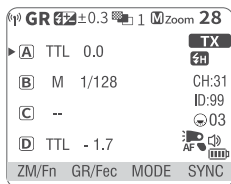

Pressing function buttons 2 or 3 will set the mode to TTL.

Master Control Unit:

- Press Function Button 2 <GR/Fec> to select the group, and then press Function Button 3 <MODE> to choose the TTL option.

- Rotate knob to set exposure compensation for selected group.

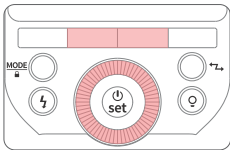

Press and hold function button 2 <GR/Fec>, then turn knob to set exposure compensation for all groups.

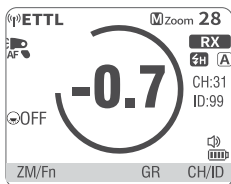

RX Unit

(1) Transmitter Unit Setting

- Attach a camera Z2PRO-C flash on the camera and set it as the transmitter unit. Set it to ON to flash.(Page 17)
- A signal transmitter can also be used as the TX control unit. The transmitter can control the ZOOM value of the Z2PRO-C, but the ZOOM must be set to auto  mode.

(2) Receiver Unit Setting

Mount the Z2PRO-C camera flash as the wireless Receiver Unit.

(3) Check the communication channel

Set the channel of the Transmitter unit and Receiver unit to the same values. Set the Transmitter unit channel(page 17). The Receiver unit can be set to press the function button 3/4 (corresponding Gr/CH) to adjust the group channel.

(4) Position the camera and flashes

Position the camera and flashes as indicated by the picture. (Page 15)

(5) Check if the flash is ready

- Check that the Transmitter flash ready indicator is lit
- When the Receiver flash ready indicator is ready, the AF-assist beam lighting area will flash at 1 second intervals.

(6) Check the flash operation

- Press the Transmitter unit's Test Button <  >.
- The Receiver unit should then flash. If it doesn't, check the receiver is placed within the operating range.

Using Automatic Wireless Flash with Multiple Receiver (RX) Units

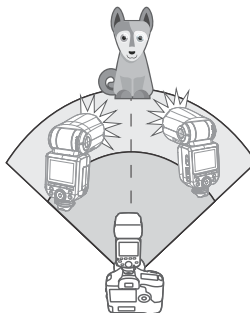

When a larger flash output is required, you can increase the number of RX units and flash them as a single flash.

To add receiver (RX) units, use the same steps as setting "automatic wireless flash with a single Receiver unit ". Any flash group can be set (A/B/C/D/E).

When the number of RX units is increased or the TX flash is set to ON, automatic control ensures that all flashes fire at the same flash output so that the total flash output meets the standard exposure.

- * Press the depth-of-field preview button on the camera to fire a modeling flash.
- * If the auto power off of the RX unit has kicked in, press the test button on the TX unit to trigger a flash button enables the RX unit. Please note that the flash cannot be tested during the camera's metering time.
- * It is possible to modify the amount of time before the RX unit automatically powers off.
- * It is also possible to set so that the autofocus assist transmitter does not flash when the RX unit has finished powering up.

Using a fully automatic wireless flash

The flash exposure compensation (FEC) and other settings set on the TX unit are also set automatically in the RX unit. Operation of the RX unit is not required. The following settings can be used for shooting with no line flash in the same way as for normal flash shooting.

- ① Flash Exposure Compensation
- ② Manual Flash
- ③ Flash Exposure Lock
- ④ Stroboscopic Flash

About Transmitter Unit

Two or more TX units can be used. By configuring multiple cameras with TX units, you can change the cameras used for shooting while maintaining the same lighting (RX units).

8. M: Manual Wireless Flash Shooting

Shooting with manual flash with no line (multi-flash) allows you to set different flash outputs for each RX unit (flash group) for shooting. All parameters need to be set on the TX control unit.

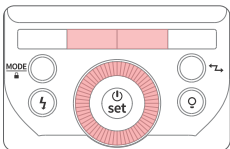

- Press Function Button 2 <GR/Fec> to select the group, and then press Function Button 3 <MODE> to choose the M option.

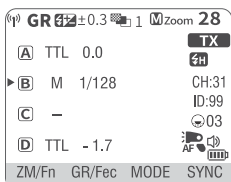

- Rotate the adjustment knob to adjust the flash output for the flash group, and press the Setting button to confirm.
- Taking pictures. Each group fired at the set flash ratio.

Press and hold function button 2 <GR/Fec>, then turn knob to set exposure compensation for all groups.

Setting <M> Flash Mode

You can directly operate the Receiver unit to manually set the manual flash or stroboscopic flash.

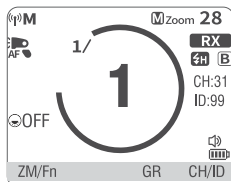

- Setting the Receiver unit.
- Setting flash mode to <M>.
 - Press <MODE> button so that <M> displays.
 - Set the manual flash output.

9. Multi: Wireless Flash Shooting with Manual Flash

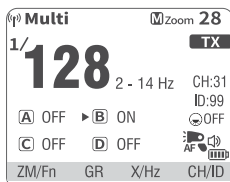

To set the <MULTI> strobe mode.

- In the main control screen mode, press the <MODE> mode selection button to display <MULTI>.
- Set the strobe flash setting in the main control screen mode.

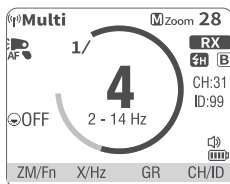

In receiver unit mode, press the <MODE> button to display <MULTI>.

Troubleshooting: 2.4G wireless flash misfiring

- Interference of the 2.4g signal resulting from external factors (such as a wireless hub, 2.4G Wi-Fi routing, Bluetooth equipment, etc.)
 - Please adjust the channel CH setting of the transmitter(+10 is recommended) to find a channel without interference, or turn off other 2.4G devices in close proximity whilst working.
- Please ensure that the flash is fully recycled, the flash ready indicator is on and that the overheat protection feature hasn't been triggered.
 - Please lower the flash setting by changing to manual mode (M) If the device is in TTL mode, you need to fire a preflash)
- Please check whether the flash detector and the receiving device are running low on power
 - Please replace the batteries (1.5V disposable alkaline batteries are recommended for the flash receiver battery)

Other Applications

3. TCM - One key switching E-TTL/M mode:

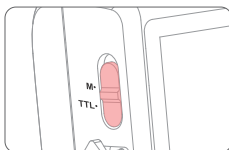

Utilize E-TTL auto mode for quick metering while retaining metering data, and seamlessly switch to manual mode for precise adjustments.

Toggle the TCM button to 'M' for one-touch switching.

2. Sync Triggering

The Sync Cord Jack is a $\Phi 2.5\text{mm}$ connector. Insert a trigger plug here and the flash will be fired in sync with the camera shutter.

3. Auto Focus Assist Beam

In low-brightness or low-contrast shooting situations, the flash's built-in autofocus assist lamp turns on to make autofocusing easier. When focusing is difficult, the red autofocus assist light comes on.

To turn off the autofocus function, set "AF" to "OFF" in C.Fn.

* If the user finds that the assisted focus light is not on when using it, it is because the camera is already accurately focused.

Position	Operating range
Center	0.6-10m / 2.0-32.8 feet
Periphery	0.6-5m / 2.0-16.4 feet

4. Bounce Flash

By pointing the flash head toward a wall or ceiling, the flash will bounce off the surface before illuminating the subject. This can soften shadows behind the subject for a more natural-looking shot. This is commonly known as a 'bounce flash'.

Position the flash head to set the bounce direction.

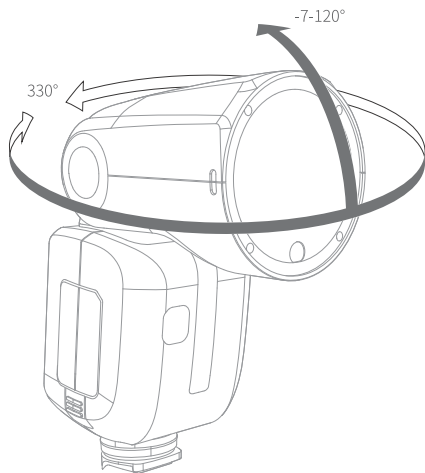

* If the wall or ceiling is too far away, the bounced flash might be too weak and result in underexposure.

* The wall or ceiling should be a plain, white color for high reflectance. If the bounce surface isn't white it will result in "off color" photos.

5. ZOOM: Set the flash coverage

The flash coverage can be set automatically or manually. It can be set to match the lens focal length from 28mm to 105mm. In auto zoom, the focal length changes with the camera's zoom lens to provide the best flash effect.

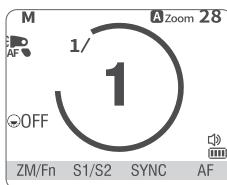

When performing a manual zoom, short press function button 1 <ZM/Fn>.



- Turn the Select Dial to change the flash coverage.
- If **A** is displayed, the flash coverage will be set automatically.

* If you set the flash coverage manually, make sure it covers the lens focal length so that the picture will not have a dark periphery.

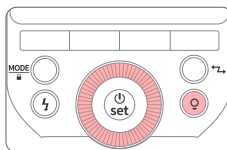
6. Modeling Lamp



Switching on the Modeling Lamp

- Short press the modeling lamp button <  >.
- Rotate the adjustment knob to set the modeling lamp brightness level from 01 to 10.
- Short press the <  > button to confirm the selection.

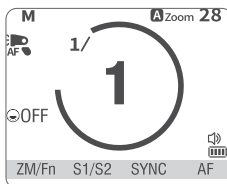

* Long press the styling light button <  >, then rotate the adjustment knob to switch between styling lights <  > and styling lights <  >



7. Modeling Flash

If your camera has a depth-of-field preview button, pressing it activates a 1-second continuous flash, known as modeling flash. This feature helps you observe the effect of the light and shadow on your subject and evaluate the illumination balance, whether you're using wireless or standard flash.

* Avoid triggering the modeling flash more than 10 times in quick succession. If you've performed 10 consecutive modeling flashes, please allow the flash to cool down for at least 10 minutes to prevent overheating or damage to the flash head.

* Please note that modeling flash is not supported on EOS 300 and B models.

Use the Customize function to complete settings according to the following chart.

Custom Function Symbols	Function	Setting No.	Set-Up and Instructions
AF	AF-assist beam	ON	on
		OFF	off
STBY	Auto sleep setting	ON	on
		OFF	off
RX STBY	Receiver auto power off timer	60min	60min
		30min	30min
		OFF	off
		START	Start search for idle channel
SCAN	Scan for idle channels	OFF	off
		START	Start search for idle channel
CH	Channel setting	01-32	Choose a channel from 01-32
ID	Wireless ID	OFF	off
		01-99	Choose any figure from 01-99
BEEP	Beeper	ON	on
		OFF	off
FEB ACL	FEB auto cancel	ON	on
		OFF	off
TX	Transmitter unit control	OFF	off
		ON	on
DIST	Flash distance	1-100M	1-100M flash
		0-10M	0-10M flash
LIGHT MODE	Modeling Lamp		Top Modeling Lamp
			Bottom Modeling Lamp
MODEL	Modeling Lamp	CONT	Modeling Light Continuous
		INTER	Modeling light interrupted
RX AF	Slave mode recycling indicator	OFF	off
		ON	on
RX COMPAT	2.4G Wireless X System	OFF	off
		ON	on

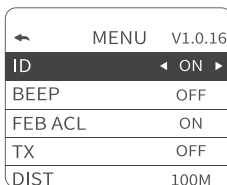
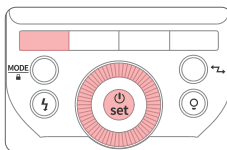

1. Long press the function button 1 <ZM/Fn> to access the customized menu.
2. Rotate the adjustment knob to choose a parameter.
3. Press the Setting button to enter the parameter adjustment mode.
4. Rotate the adjustment knob to modify the parameter.
5. Press the Setting button again to confirm the parameter.
6. Short press function button 1 to exit.

Control using the Camera's Menu Screen

Mount the flash directly onto the Canon EOS camera to control the flash using the camera's menu screen. Please refer to the camera instructions for details.

1. Setting Camera Flash Functions

The following flash functions can be set according to different flash modes.

- ① Flash mode
- ② Shutter sync
- ③ FEB
- ④ FEC
- ⑤ Flash firing
- ⑥ Clear camera flash settings

2. Custom Functions of Camera Flash

C.Fn-00, C.Fn-01, C.Fn-03, C.Fn-04, C.Fn-08, C.Fn-20, C.Fn-22,7 in total.

Clear All Flash Custom Functions

Flash function settings screen

Flash C.Fn settings screen

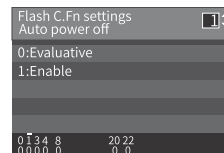
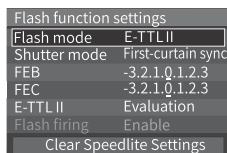

* Screen view taken from the EOS-1D Mark III.

* If flash exposure compensation has already been set using the camera flash, flash exposure compensation cannot be set with the camera. To set it with the camera, the camera flash's flash exposure compensation must be set to "0".

* If any Flash Custom Functions and flash settings, other than flash exposure compensation, have been set by both the camera and the flash, the last applied settings will be used.

1. Over-Temperature Protection

- ① To prevent the flash head from deteriorating and overheating, it is recommended not to fire more than 100 continuous flashes in fast succession at 1/1 full power. After 100 continuous flashes, pause the use of the flash for at least 10 minutes.
- ② If you fire more than 100 continuous flashes and then fire more flashes in short intervals, the inner over-temperature protection function may be activated. The recycling time will be longer (over 10s). If this occurs, the use of the device should be paused for at least 10 minutes for the flash unit to operate as normal.

Number of flashes that will activate over-temperature protection:

Power	Number of Flashes
1/1	100
1/2	150
1/4	300
1/8	300
1/16	1100
1/32	3500
1/64	
1/128	
1/256	

2. Other Safety Functions

* The system provides real-time protection to secure the device and your safety. The following lists prompts for your reference:

Prompts on LCD Panel	Indicates
E1	A fault has developed with the flash's recycle system so that the flash cannot fire. Please restart the flash unit. If the problem still exists, please send this product to a maintenance center.
HOT	The flash will disable when the temperature inside the unit is too high in which case you should stop using the flash for 10 minutes.

Model	Z2PRO-C
Compatible Cameras	Canon EOS cameras (E-TTL II autofocus)
Power(1/1 output)	76Ws
Flash Coverage	28-105 mm
	Auto zoom , Manual zoom
	Swinging/tilting flash head (bounce flash): 0 to 330° horizontally and -7° to 120° vertically
Flash Duration	1/180 to 1/20000 seconds
Exposure Control	
Exposure control system	E-TTL II autofocus and manual flash
Flash exposure compensation (FEC)	Manual, FEB: ±3 stops in 1/3 stop increments (Manual FEC and FEB can be combined.)
Flash exposure lock (FEL)	Use <FEL> button or < * > button
Sync mode	High-speed sync (up to 1/8000 seconds), first-curtain sync, and second-curtain sync
Multi flash	Autonomy(up to 100 times, 199Hz)
Wireless flash (radio 2.4G transmission)	
Wireless flash function	Transmitter, Receiver, Off
Transmitter groups	A, B, C, D
Controllable Receiver groups	A, B, C, D, E (E group can be controlled by QPRO series flash trigger available on Newer.com)
Transmission range (approx.)	100m
Channels	32 Groups:01-32
ID	01-99
Frequency Range	2412.75MHz-2464.25MHz
Maximum radio-frequency power	5.30dBm
Modeling Flash	Using the camera's depth-of-field preview button
Auto Focus Assist Beam	
Effective range (approx.)	Center: 0.6-10m / Periphery: 0.6-5m
Power source	
Built-in Li-ion battery	7.2V/3000mAh Li-ion battery
Recycle time	Approx 1.5 seconds. Red LED indicator will light up when the flash is ready.
Number of flash in full power	Approx. 600
Energy-saving	Auto Power off after approx. 90 seconds of idle operation. (60 minutes if set as Receiver)
Sync Triggering Mode	Hotshoe, 2.5mm sync line
Modeling Lamp	
Power	2W
Color Temperature	3300K±200K
Dimensions	
Volume	76*76*206 mm
Net weight without battery	460g
Weight with battery	580g
Operating Temperature	0°C ~ 40°C

If you experience a problem with the device, please refer to this Troubleshooting Guide.

1. The Camera Flash does not fire

- ① The camera flash is not attached securely to the camera.
→ Attach the hot shoe base mount of the flash securely to the camera.
- ② The electrical contacts of the camera flash and camera are dirty.
→ Clean the contacts.
- ③ < 1/ > or < 1H > is not displayed in the viewfinder of camera.
→ Wait until the flash is fully recycled and the flash ready indicator lights up.
→ If the flash ready indicator lights up, but < 1/ > or < 1H > is not displayed in the view finder, check whether this flash unit is securely attached to the camera hotshoe.
→ If the flash ready indicator does not light up after a long period of time, check whether the battery power is sufficient. If the battery is low (low battery voltage icon flashes on the flash screen), please replace the battery immediately.

2. Auto power off

- ① After 90 seconds of idle operation, auto power off will have activated if the flash is set as Transmitter (Master).
→ Press the shutter button halfway or press any flash button to wake up.
- ② After 60 minutes (or 30 minutes) of idle operation, the flash unit will enter sleep mode if it is set as Receiver (Slave).
→ Press any flash button to wake up.

3. Auto zoom does not work.

The camera flash is not attached securely to the camera.
→ Attach the camera flash's mounting base to the camera.

4. The flash exposure is underexposed or overexposed.

- ① There was a highly reflective object (e.g. glass window) in the picture.
→ Use FE lock (FEL).
- ② You used high-speed sync.
→ With high-speed sync, the effective flash range will be shorter. Make sure the subject is within the effective flash range displayed.
- ③ Use Manual Flash mode.
→ Set the flash mode to E TTL or modify the flash output.

5. Photos have dark corners or only parts of the target subject are illuminated.

The focal length of lens exceeds the flash coverage.
→ Check the focal length that has been set. This flash unit has the flash coverage between 28 and 105mm, which fits medium-format cameras.

The firmware of this product can be upgraded through the USB port. The latest software announcements and instructions will be published on the official website.

- ※ This product does not come with a USB cable for the firmware upgrade. Please purchase separately. The USB port of this product is a Type-C port. Please use only a USB Type-C cable.
- ※ Upgrading the firmware requires Neewer Firmware software support. Please download and install "Neewer Firmware Update", and then select the corresponding firmware file before updating.
- ※ As the product is undergoing a firmware upgrade, please refer to the latest electronic version of the manual.

Restore factory settings

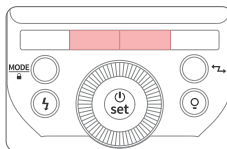

- ① Press and hold both Function buttons 2 and 3 simultaneously.

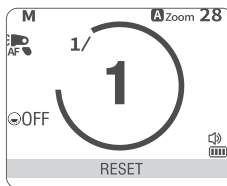

- ② "RESET" will appear on the screen to indicate that the factory settings have been restored.

Compatible Cameras

The item is compatible with following Canon camera models:

R	R3	R5	M6	6D	7D	R6	60D	50D	70D	80D	90D
1DX	450D	500D	550D	600D	650D	850D	1100D	3000D			
750D/T6i	1DMark III	5D Mark II	5D Mark III	5D Mark IV							
R8	6D Mark II	760D/T6s	800D/T7i	7D Mark II	77D/9000D						
77D/9000D	1500D/2000D/T7	200D II/250D/SL3	R5C								
R7	R10										